



# LEDVANCE LUMINAIRES

## DOWNLIGHT RT

### DUAL SELECTABLE

LEDVANCE LUMINAIRE SPECIFICATION DATA

Catalog #	Comments
Project	
Type	
Prepared by	

**PERFORMANCE CLASS™**



<p><b>LENS</b> Uniform, glare free illumination</p> <p><b>HIGH PERFORMANCE</b> Up to 120LPW</p> <p><b>UNIFORM LIGHT</b> 85° Beam Angle</p> <p><b>CUSTOMIZATION</b> Optional Field Installed Trim Rings</p> <p><b>FLEXIBILITY</b> Selectable CCT: 2700/3000/3500/4000/5000K Selectable Output: 3 Step Dimming</p>	<p><b>QUALITY LIGHT</b> CRI&gt;90, R9&gt;50</p> <p><b>DIMMING</b> 100-10% Phase-cut &amp; 0-10V dimming in the same product</p> <p><b>EMERGENCY BATTERY BACKUP READY</b> (Field installable) kit provides up to 2hr illumination</p> <p><b>ENERGY EFFICIENT</b> IC &amp; Air Tight rated</p> <p><b>INSTALLATION</b> Max Ceiling Thickness: 1.97" (50mm)</p>
--	---

**CERTIFICATIONS & LISTINGS**

- UL listed for US & Canada
- RoHS Compliant
- FCC Compliant
- Wet Location
- Certified airtight as per ASTM E283-04
- IC Rated for insulation contact
- IP44
- Title 24
- TAA Compliant
- Energy Star

**AMBIENT OPERATING TEMPERATURE**

- -4°F to 104°F (-20°C to 40°C)
- 32°F to 104°F (0°C to 40°C) with battery

**ELECTRICAL**

- Input voltage: 120-277V or 120-347V
- Surge Protection: 2.5 kV
- THD: <= 20%
- 16 inches of input wires
- Power Factor: >0.9 @120V, >0.7@277V or 347V

**DESCRIPTION**

The LEDVANCE Performance Class Downlight RT Dual Selectable luminaires are offered in 4", 6", 8" and 10" sizes and provide high performing light optimized for both new construction and retrofit applications where pin-based compact fluorescent lamps have previously been used. Easily fits in most standard frames and offers care-free universal 120V TRIAC/ELV Phase-cut or 0-10V dimming. The RT family is emergency battery back-up ready and can be customized with the optional color finish trims.

**APPLICATION**

- Commercial applications
- Office
- Public & commercial buildings
- New installations or retrofit of existing installations
- Schools
- Big Box Retail
- Hotels, shops, hospitality, residential interiors

**RATED LIFE**

- 100,000 hours (L70) @ 77°F/25°C

**WARRANTY**

- 5-Year Limited Warranty
- NLB Trusted Warranty Program



## ORDERING GUIDE

RT	XX	SXXXX	XXX	D	9	XXX	WH
PRODUCT NAME	SIZE	SELECTABLE LUMENS	VOLTAGE	DIMMING	CRI	COLOR TEMP	FINISH
RT = LED Downlight	4 = 4" 6 = 6" 8 = 8" 10 = 10"	S900 = 500/700/900lm S1000 = 600/800/1000lm S1500 = 900/1200/1500lm S2500 = 1000/1800/2500lm S3500 = 1800/2700/3500lm S4500 = 2800/3500/4500lm	UNV = 120-277V UNH = 120-347V	D = TRIAC / ELV / 0-10V	9 = >90, R9>50	SC3 = Selectable 2700, 3000, 3500, 4000 or 5000K	WH = White

## ORDERING INFORMATION

ITEM #	ORDERING ABBREVIATION	WATTAGE (W)	INPUT VOLTAGE (V)	CCT (K)	TOTAL LUMENS (LM)	LPW	FINISH
67685	RT4S1000UNVD9SC3WH	6/8/10	120-277	2700/3000/3500/4000/5000	600/800/1000	100	WH
67686	RT6S900UNVD9SC3WH	5/7/9	120-277	2700/3000/3500/4000/5000	500/700/900	100	WH
67687	RT6S2500UNVD9SC3WH	10/17/21	120-277	2700/3000/3500/4000/5000	1000/1800/2500	119	WH
67688	RT8S1500UNVD9SC3WH	9/12/15	120-277	2700/3000/3500/4000/5000	900/1200/1500	100	WH
67689	RT8S3500UNVD9SC3WH	16/24/30	120-277	2700/3000/3500/4000/5000	1800/2700/3500	117	WH
67690	RT10S4500UNVD9SC3WH	24/30/37	120-277	2700/3000/3500/4000/5000	2800/3500/4500	122	WH
67691	RT4S1000UNHD9SC3WH	6/8/10	120-347	2700/3000/3500/4000/5000	600/800/1000	100	WH
67692	RT6S2500UNHD9SC3WH	10/17/21	120-347	2700/3000/3500/4000/5000	1000/1800/2500	119	WH
67693	RT8S3500UNHD9SC3WH	16/24/30	120-347	2700/3000/3500/4000/5000	1800/2700/3500	117	WH

## PHYSICAL INFORMATION

DESCRIPTION	DIAMETER	HEIGHT	WEIGHT
RT4S1000UNVD9SC3WH	5.51in (140mm)	3.72in (94.5mm)	0.86lb (0.39kg)
RT6S900UNVD9SC3WH	7.36in (187mm)	4.08in (103.6mm)	1.08lb (0.49kg)
RT6S2500UNVD9SC3WH	7.36in (187mm)	4.08in (103.6mm)	1.08lb (0.49kg)
RT8S1500UNVD9SC3WH	9.45in (240mm)	4.45in (113mm)	1.37lb (0.62kg)
RT8S3500UNVD9SC3WH	9.45in (240mm)	4.45in (113mm)	1.37lb (0.62kg)
RT10S4500UNVD9SC3WH	11.26in (286mm)	4.45in (113mm)	1.61lb (0.73kg)
RT4S1000UNHD9SC3WH	5.51in (140mm)	3.72in (94.5mm)	0.86lb (0.39kg)
RT6S2500UNHD9SC3WH	7.36in (187mm)	4.08in (103.6mm)	1.08lb (0.49kg)
RT8S3500UNHD9SC3WH	9.45in (240mm)	4.45in (113mm)	1.37lb (0.62kg)

### 4 INCH

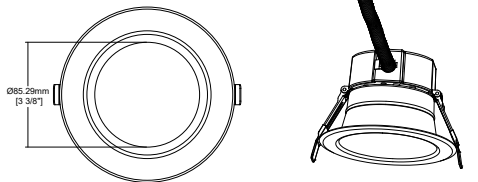
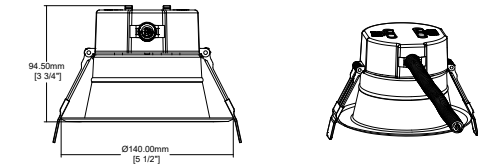

### 6 INCH

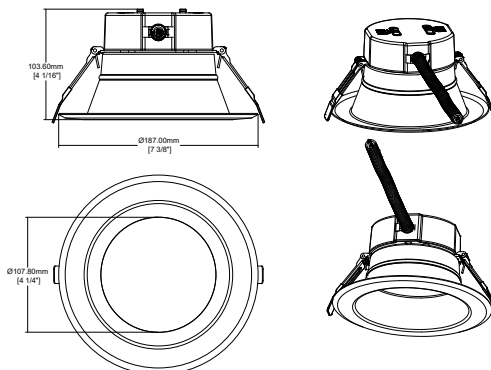



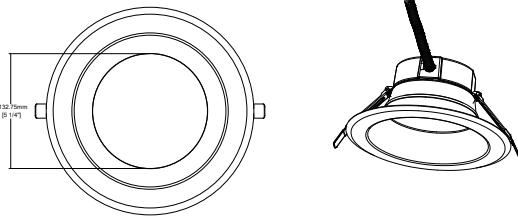
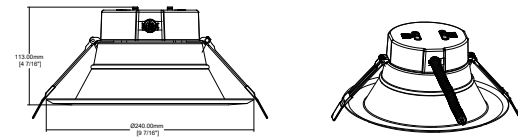



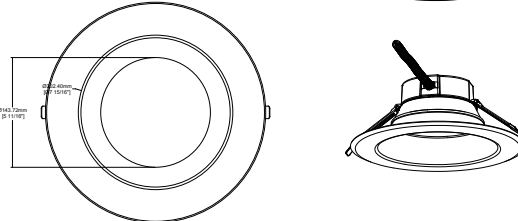
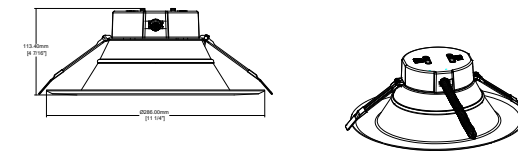









### 8 INCH



### 10 INCH



## OPTIONAL ACCESSORIES

ITEM #	ORDERING ABBREVIATION	PRODUCT DESCRIPTION	
<b>TRIM RINGS</b>			
67426	RT4TRIMSSWH	4" Semi-Specular Trim Ring White Flange	
67427	RT6TRIMSSWH	6" Semi-Specular Trim Ring White Flange	
67428	RT8TRIMSSWH	8" Semi-Specular Trim Ring White Flange	
67429	RT10TRIMSSWH	10" Semi-Specular Trim Ring White Flange	
65710	RT4TRIM5ADKBZ	4" Dark Bronze Trim Ring	
65711	RT4TRIM5ASN	4" Satin Nickel Trim Ring	
65712	RT4TRIM5ABLK	4" Black Trim Ring	
65713	RT6TRIM5ADKBZ	6" Dark Bronze Trim Ring	
65714	RT6TRIM5ASN	6" Satin Nickel Trim Ring	
65715	RT6TRIM5ABLK	6" Black Trim Ring	
65716	RT8TRIM5ADKBZ	8" Dark Bronze Trim Ring	
65717	RT8TRIM5ASN	8" Satin Nickel Trim Ring	
65718	RT8TRIM5ABLK	8" Black Trim Ring	
65719	RT10TRIM5ADKBZ	10" Dark Bronze Trim Ring	
65720	RT10TRIM5ASN	10" Satin Nickel Trim Ring	
65721	RT10TRIM5ABLK	10" Black Trim Ring	

## OPTIONAL ACCESSORIES (CONTINUED)

ITEM #	ORDERING ABBREVIATION	PRODUCT DESCRIPTION
<b>TRIM RING EXTENDERS</b>		
62788	RT685ATRIMEXT	6-8" Trim Ring Extender (Goof Ring) for 8" cans
62789	RT8105ATRIMEXT	8-10" Trim Ring Extender (Goof Ring) for 10" cans
62790	RT8125ATRIMEXT	8-12" Trim Ring Extender (Goof Ring) for 12" cans
62791	RT10125ATRIMEXT	10-12" Trim Ring Extender (Goof Ring) for 12" cans



<b>EMERGENCY BATTERY BACK-UP</b>		
62367	EMBB2A8WUNVDC	100-277V 2A 8W Emergency Battery Back-up 90min.
62368	EMBB2A8WUNHDC	100-347V 2A 8W Emergency Battery Back-up 90min.



<b>RECESSED ROUGH-IN FRAME</b>		
63883	LEDRT4FRAME	4" Recessed rough-in frame with Junction Box (RT4)
71708	LEDRT6HOFFRAME	6" Recessed rough-in frame with Junction Box (RT6)
71709	LEDRT8FRAME	8" Recessed rough-in frame with Junction Box (RT8/10)



## TRIM RING EXTENDER DIMENSIONS

DESCRIPTION	OUTER DIAMETER (A)	INNER DIAMETER (B)	THICKNESS (C)
62788	9.44in (240.00mm)	5.44 (138.73mm)	0.375in (9.50mm)
62789	11.44in (290.80mm)	7.125 (180.75mm)	0.438in (10.50mm)
62790	13.44in (341.60mm)	7.125 (180.75mm)	0.438in (10.80mm)
62366	13.44in (341.60mm)	8.125 (205.83mm)	0.438in (10.80mm)

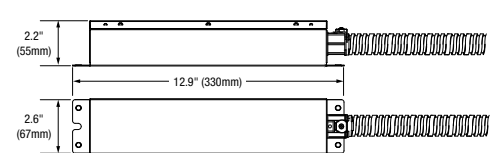
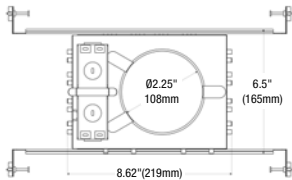
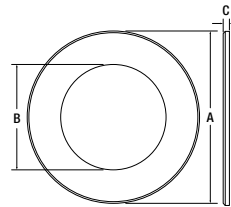

## EMBB COMPATIBILITY

ITEM #	ORDERING ABBREVIATION	EMBB ITEM #	EMBB DESCRIPTION	EMBB WATTAGE (W)*	EM LUMENS (LM)*
67685	RT4S1000UNVD9SC3WH	62367 / 62368	EMBB2A8WUNVDC / EMBB2A8WUNHDC	10	960*
67686	RT6S900UNVD9SC3WH	62367 / 62368	EMBB2A8WUNVDC / EMBB2A8WUNHDC	9	870**
67687	RT6S2500UNVD9SC3WH	62367 / 62368	EMBB2A8WUNVDC / EMBB2A8WUNHDC	16	1940
67688	RT8S1500UNVD9SC3WH	62367 / 62368	EMBB2A8WUNVDC / EMBB2A8WUNHDC	14	1350
67689	RT8S3500UNVD9SC3WH	62367 / 62368	EMBB2A8WUNVDC / EMBB2A8WUNHDC	16	1850
67690	RT10S4500UNVD9SC3WH	62367 / 62368	EMBB2A8WUNVDC / EMBB2A8WUNHDC	16	1940
67691	RT4S1000UNHD9SC3WH	62368	EMBB2A8WUNHDC	10	960*
67692	RT6S2500UNHD9SC3WH	62368	EMBB2A8WUNHDC	16	1940
67693	RT8S3500UNHD9SC3WH	62368	EMBB2A8WUNHDC	16	1850

† At the highest wattage. \*Not compatible with 6W (lowest) setting. \*\*Not compatible with 5W (lowest) setting

## EMBB WIRING DIAGRAM

### Wiring diagram

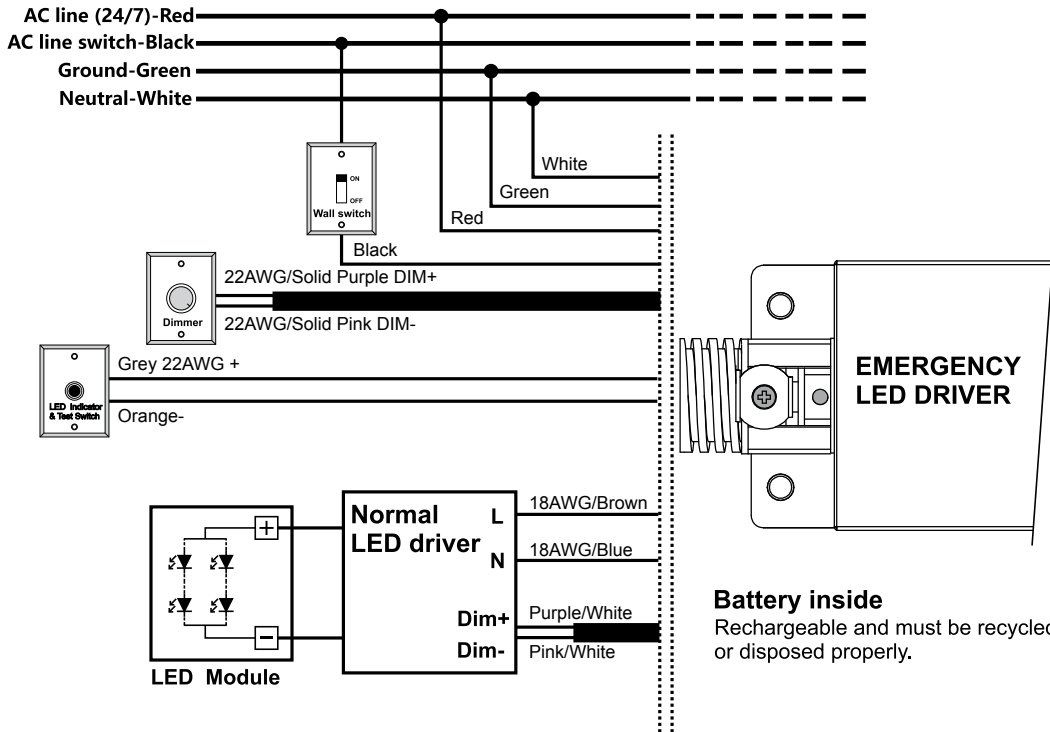

### DIMMER COMPATIBILITY

MAKE	DIMMER TYPE	MODEL
<b>PHASECUT DIMMERS</b>		
Leviton SureSlide	L	6674
Lutron Maestro C-L	L	MACL-153M
Lutron Diva	L	DVCL-153P
Lutron Caseta*	L	PD-6WCL*
Lutron Diva	T	DVELV-300P
Lutron Maestro	T	MAELV-600
<b>0-10V DIMMERS</b>		
Leviton	0-10V	DS710
Leviton	0-10V	IP710
Lutron	0-10V	NTSTV-DV
Lutron	0-10V	DVTV
Lutron	0-10V	DVSTV
Legrand	0-10V	H4FBL3PW

\*Not compatible with 67685 & 67686

### WATTAGE COMPARISON

TRADITIONAL SOURCE	TRADITIONAL LAMP ORIENTATION	TRADITIONAL SYSTEM WATTAGE	LED SYSTEM WATTAGE	ENERGY SAVINGS
4" Twin Tube	13W Vertical	15W	6W	60%
4" Twin Tube	18W Vertical	20W	7W	65%
4" Twin Tube	26W Vertical	28W	8W	71%
4" Triple Tube	18W Vertical	20W	9W	55%
4" Triple Tube	26W Vertical	28W	10W	64%
6" Triple Tube	18W Vertical	20W	7W	65%
6" Triple Tube	26W Vertical	28W	9W	68%
6" Triple Tube	32W Vertical	34W	10W	71%
6" Triple Tube	42W Vertical	48W	17W	65%
6" Double Tube	13W Vertical	15W	5W	67%
6" Double Tube	18W Vertical	20W	7W	65%
6" Double Tube	26W Vertical	28W	9W	68%
6" Double Tube	13W Horizontal	15W	5W	67%
6" Double Tube	18W Horizontal	20W	7W	65%
6" Double Tube	26W Horizontal	28W	9W	68%
6" Double Tube	2x13W Horizontal	28W	5W	75%
8" Triple Tube	26W Vertical	28W	12W	57%
8" Triple Tube	32W Vertical	34W	9W	74%
8" Triple Tube	42W Vertical	48W	15W	69%
8" Triple Tube	2x26W Horizontal	54W	16W	70%
8" Triple Tube	2x32W Horizontal	68W	24W	65%
8" Triple Tube	42W Horizontal	48W	15W	69%
8" Triple Tube	2x42W Horizontal	100W	30W	70%
8" Double Tube	2x13W Horizontal	28W	9W	68%
8" Double Tube	2x18W Horizontal	38W	12W	68%
8" Double Tube	2x26W Horizontal	54W	16W	70%

### INSTALLATION

- Recessed Ceiling Mount
- Optional Frame in Kits for new Construction Applications



INSTALLATION  
GUIDE

# PHOTOMETRIC INFORMATION

RT4S1000UNVD9SC3WH (2700K)

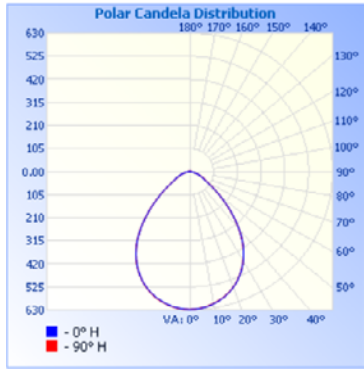

Center Beam fc	Beam Width
1.7R 217 fc	3.0 ft 3.0 ft
3.3R 57.6 fc	5.8 ft 5.8 ft
5.0R 25.1 fc	8.8 ft 8.8 ft
6.7R 14 fc	11.8 ft 11.8 ft
8.3R 9.11 fc	14.6 ft 14.6 ft
10.0R 6.27 fc	17.6 ft 17.6 ft

Vert. Spread: 82.7°  
Horiz. Spread: 82.7°

Zone	Lumens	% Luminaire
0-30	463.5	41.4%
0-40	717.6	64%
0-60	1,023.5	91.3%
60-90	97.4	8.7%
70-100	38.6	3.4%
90-120	0.003	0%
90-180	1,121.0	100%
90-180	0.0	0%
0-180	1,121.0	100%

RT6S900UNVD9SC3WH (5000K)

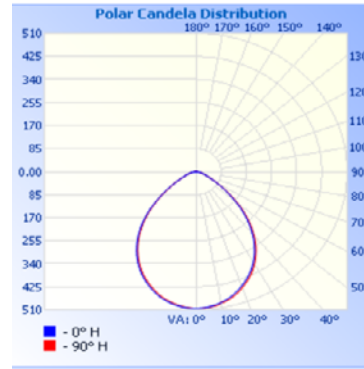

Center Beam fc	Beam Width
1.7R 175 fc	3.3 ft 3.3 ft
3.3R 46.4 fc	6.4 ft 6.4 ft
5.0R 20.2 fc	9.7 ft 9.7 ft
6.7R 11.3 fc	13.0 ft 13.0 ft
8.3R 7.33 fc	16.1 ft 16.1 ft
10.0R 5.03 fc	19.4 ft 19.4 ft

Vert. Spread: 88.1°  
Horiz. Spread: 88.2°

Zone	Lumens	% Luminaire
0-30	375.6	38.9%
0-40	591.5	61.2%
0-60	893.1	92.4%
60-90	72.9	7.6%
70-100	24.0	2.5%
90-120	0.000	0%
90-180	966.1	100%
90-180	0.000	0%
0-180	966.1	100%

RT6S2500UNVD9SC3WH (2700K)

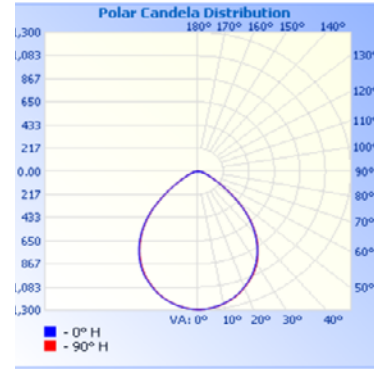

Center Beam fc	Beam Width
1.7R 447 fc	3.2 ft 3.2 ft
3.3R 119 fc	6.3 ft 6.3 ft
5.0R 51.7 fc	9.5 ft 9.5 ft
6.7R 28.8 fc	12.8 ft 12.7 ft
8.3R 18.8 fc	15.8 ft 15.8 ft
10.0R 12.9 fc	19.0 ft 19.0 ft

Vert. Spread: 87.2°  
Horiz. Spread: 87.1°

Zone	Lumens	% Luminaire
0-30	956.2	39.6%
0-40	1,501.3	62.2%
0-60	2,230.6	92.4%
60-90	184.6	7.6%
70-100	69.2	2.9%
90-120	0.0	0%
90-180	2,415.2	100%
90-180	0.1	0%
0-180	2,415.2	100%

RT8S1500UNVD9SC3WH (5000K)

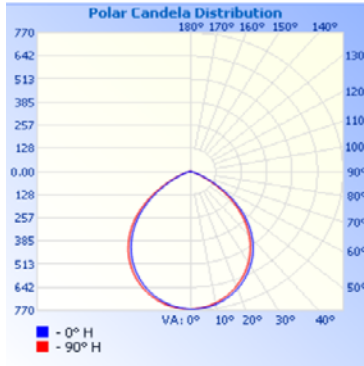

Center Beam fc	Beam Width
1.7R 264 fc	3.5 ft 3.5 ft
3.3R 70 fc	6.8 ft 6.8 ft
5.0R 30.5 fc	10.4 ft 10.4 ft
6.7R 17 fc	13.9 ft 13.9 ft
8.3R 11.1 fc	17.2 ft 17.2 ft
10.0R 7.62 fc	20.7 ft 20.7 ft

Vert. Spread: 92.0°  
Horiz. Spread: 92.1°

Zone	Lumens	% Luminaire
0-30	568.3	36.9%
0-40	901.7	58.5%
0-60	1,416.6	91.9%
60-90	125.5	8.1%
70-100	35.4	2.3%
90-120	0.005	0%
90-180	1,542.1	100%
90-180	0.005	0%
0-180	1,542.1	100%

RT8S3500UNVD9SC3WH (2700K)

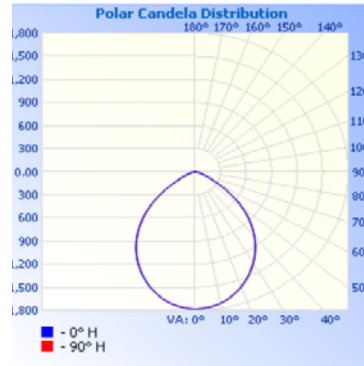

Center Beam fc	Beam Width
1.7R 617 fc	3.4 ft 3.4 ft
3.3R 164 fc	6.6 ft 6.6 ft
5.0R 71.3 fc	10.1 ft 10.0 ft
6.7R 39.7 fc	13.5 ft 13.4 ft
8.3R 25.9 fc	16.7 ft 16.7 ft
10.0R 17.8 fc	20.1 ft 20.1 ft

Vert. Spread: 90.3°  
Horiz. Spread: 90.2°

Zone	Lumens	% Luminaire
0-30	1,316.2	38%
0-40	2,078.0	59.9%
0-60	3,211.3	92.6%
60-90	255.2	7.4%
70-100	82.4	2.4%
90-120	0.0	0%
90-180	3,466.5	100%
90-180	0.0	0%
0-180	3,466.5	100%

RT10S4500UNVD9SC3WH (2700K)

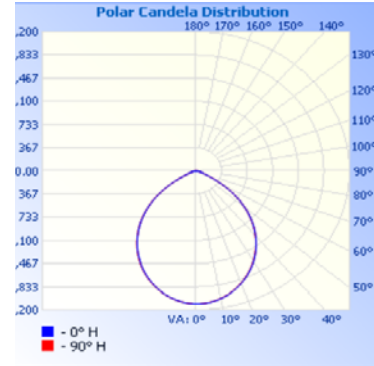

Center Beam fc	Beam Width
1.7R 728 fc	3.6 ft 3.6 ft
3.3R 193 fc	7.0 ft 7.0 ft
5.0R 84.1 fc	10.6 ft 10.6 ft
6.7R 46.8 fc	14.2 ft 14.2 ft
8.3R 30.5 fc	17.6 ft 17.6 ft
10.0R 21 fc	21.2 ft 21.2 ft

Vert. Spread: 93.4°  
Horiz. Spread: 93.4°

Zone	Lumens	% Luminaire
0-30	1,567.2	36.5%
0-40	2,492.0	58.1%
0-60	3,956.9	92.3%
60-90	331.4	7.7%
70-100	94.3	2.2%
90-120	0.0	0%
90-180	4,288.3	100%
90-180	0.1	0%
0-180	4,288.3	100%

RT4S1000UNHD9SC3WH (2700K)

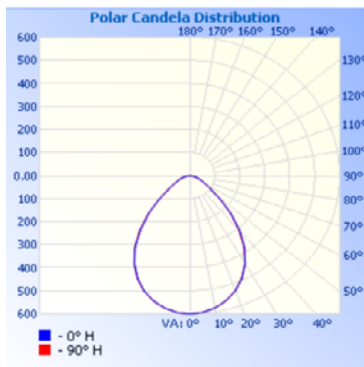

Center Beam fc	Beam Width
1.7R 208 fc	2.9 ft 2.9 ft
3.3R 55.1 fc	5.6 ft 5.6 ft
5.0R 24 fc	8.5 ft 8.6 ft
6.7R 13.4 fc	11.5 ft 11.5 ft
8.3R 8.71 fc	14.2 ft 14.2 ft
10.0R 6 fc	17.1 ft 17.1 ft

Vert. Spread: 81.1°  
Horiz. Spread: 81.1°

Zone	Lumens	% Luminaire
0-30	439.4	42.1%
0-40	675.4	64.8%
0-60	953.4	91.4%
60-90	89.3	8.6%
90-180	1,042.7	100%

RT6S2500UNHD9SC3WH (5000K)

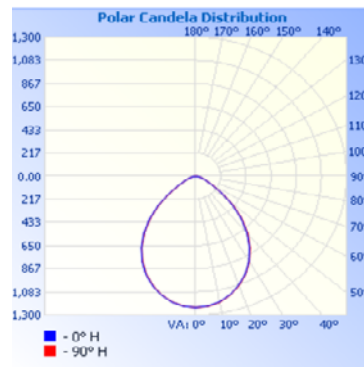

Center Beam fc	Beam Width
1.7R 425 fc	3.1 ft 3.2 ft
3.3R 113 fc	6.1 ft 6.1 ft
5.0R 49.2 fc	9.3 ft 9.3 ft
6.7R 27.4 fc	12.4 ft 12.4 ft
8.3R 17.8 fc	15.4 ft 15.4 ft
10.0R 12.3 fc	18.5 ft 18.5 ft

Vert. Spread: 85.6°  
Horiz. Spread: 85.7°

Zone	Lumens	% Luminaire
0-30	902.2	40%
0-40	1,407.5	62.4%
0-60	2,082.1	92.3%
60-90	174.5	7.7%
90-180	2,256.6	100%

RT8S3500UNHD9SC3WH (2700K)

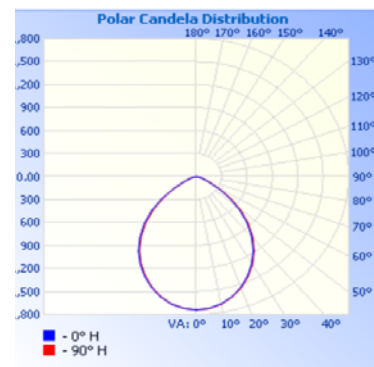

Center Beam fc	Beam Width
1.7R 602 fc	3.4 ft 3.3 ft
3.3R 160 fc	6.5 ft 6.5 ft
5.0R 69.6 fc	9.9 ft 9.8 ft
6.7R 38.8 fc	13.2 ft 13.2 ft
8.3R 25.3 fc	16.4 ft 16.3 ft
10.0R 17.4 fc	19.7 ft 19.7 ft

Vert. Spread: 89.2°  
Horiz. Spread: 89.1°

Zone	Lumens	% Luminaire
0-30	1,279.2	38.2%
0-40	2,013.5	60.1%
0-60	3,097.3	92.4%
60-90	251.7	7.6%
90-180	3,352.0	100%

**HOLE CUT TEMPLATES**

**RT4 HOLE CUT TEMPLATE**

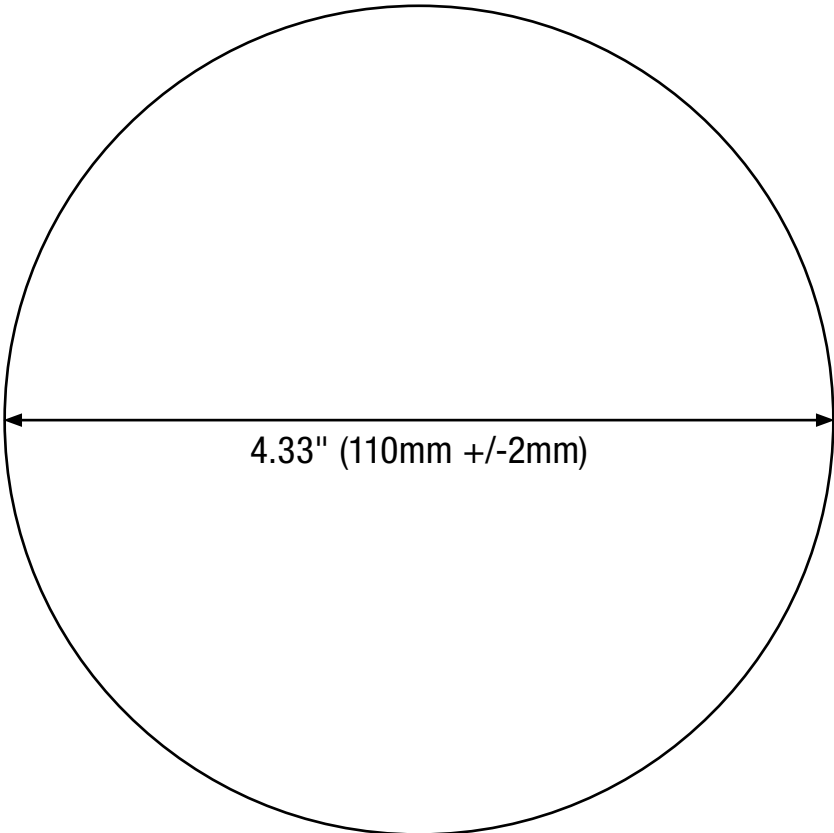

**RT6 HOLE CUT TEMPLATE**

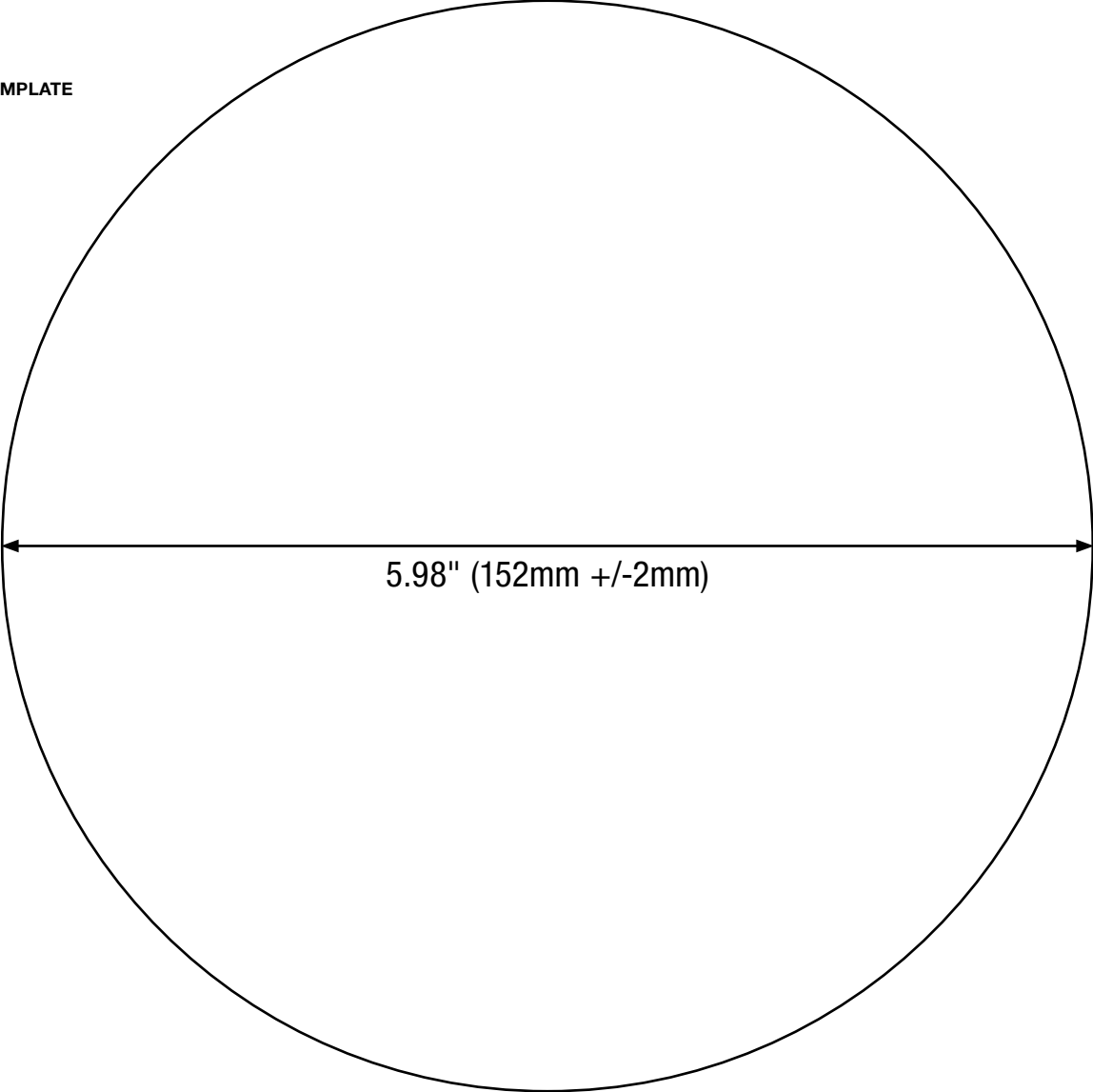

**HOLE CUT TEMPLATES**

**RT8 HOLE CUT TEMPLATE**

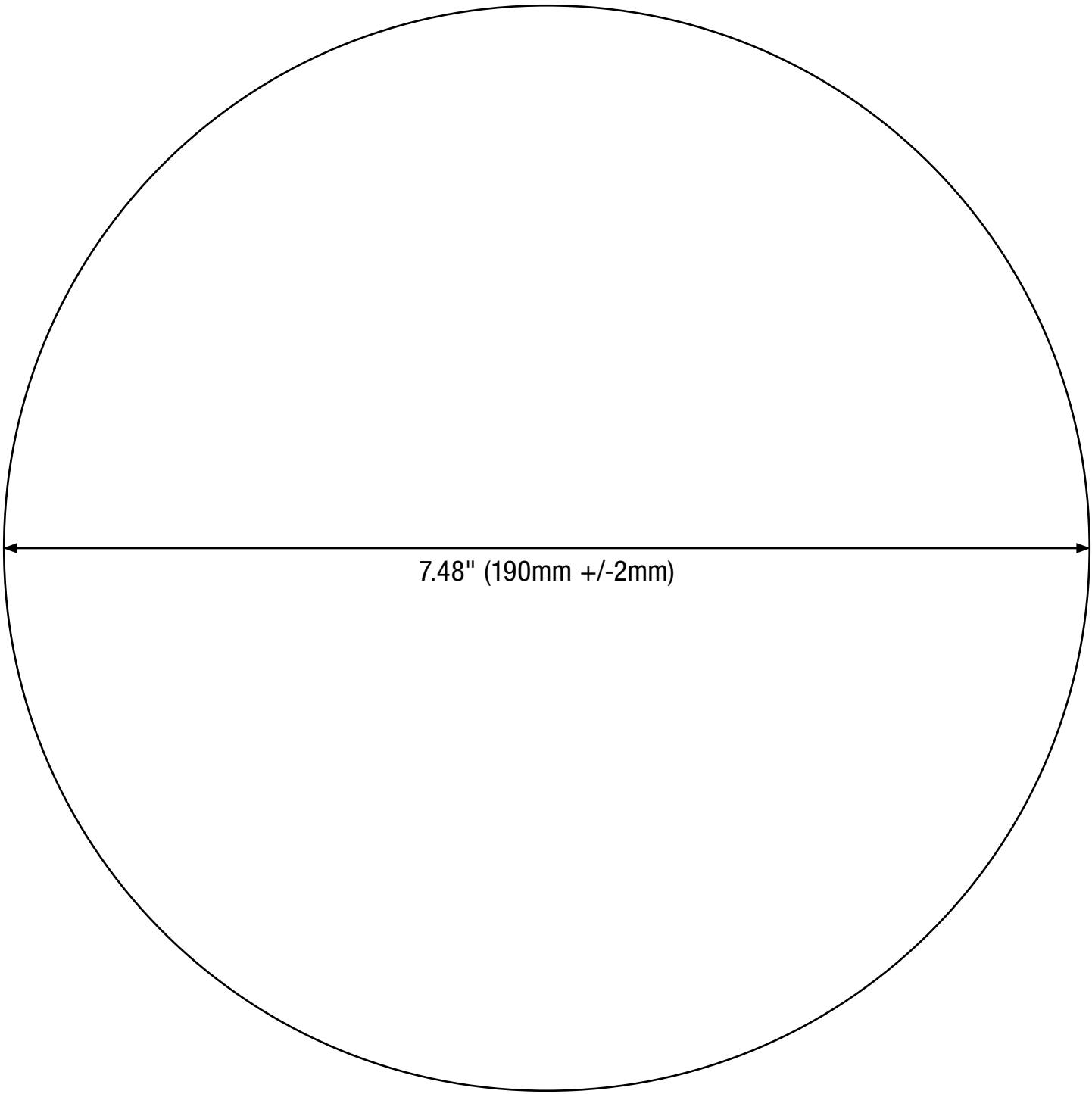

## HOLE CUT TEMPLATES

### RT10 Hole Cut Template

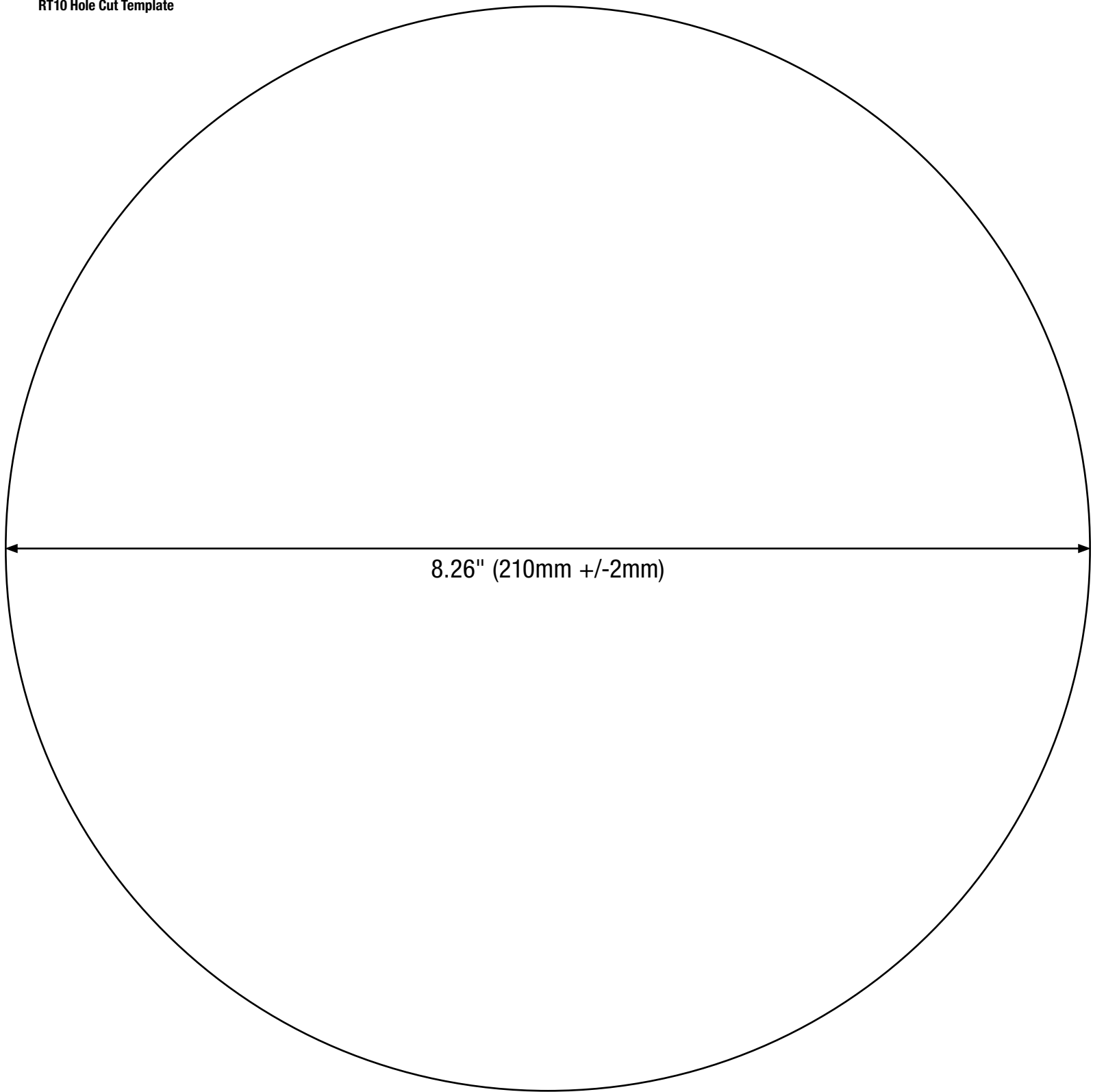

8.26" (210mm +/-2mm)



#### LEDVANCE NORTH AMERICAN HEADQUARTERS

LEDVANCE LLC.  
181 Ballardvale Street, Suite 203  
Wilmington, MA 01887  
Phone: +1 978 753 5000

#### LEDVANCE CANADIAN HEADQUARTERS

LEDVANCE LTD./LTE.  
5450 Explorer Drive, Suite 100  
Mississauga, Ontario L4W 5N1  
Phone: +1 905 361 93 33

#### LEDVANCE.COM/EN-US

LEDVANCE is a registered trademark.  
All other trademarks are those of their respective owners.  
Specifications subject to change without notice.

© 2026 LEDVANCE LLC